



TROJAN™

DUMBBELL PRO 300 BENCH

ADJUSTABLE SEAT &
BACKREST

FULLY
FOLDABLE

STRENGTH
& TONING



USER MANUAL

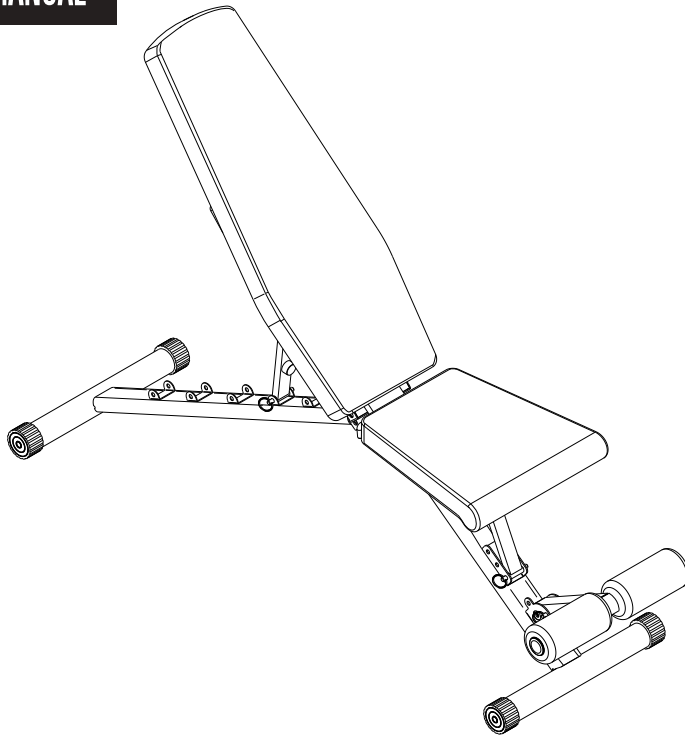

CAUTION

READ ALL PRECAUTIONS AND
INSTRUCTIONS IN THIS MANUAL
BEFORE USING THIS EQUIPMENT.
KEEP THIS MANUAL FOR
FUTURE REFERENCE.

Visit facebook.com/trojanhealth
www.trojanhealth.co.za
www.instagram.com/trojanhealth



INDEX

- **Important Safety Instructions** _____ 3
- **Pre Assembly Check List** _____ 5
- **Hardware & Tool List** _____ 6
- **Parts List** _____ 7
- **Exploded Drawing** _____ 8
- **Folding Steps** _____ 9
- **Exercise Instructions** _____ 11
- **Fitness Tips & Techniques** _____ 12
- **Conditioning Guidelines** _____ 13
- **Warm Up & Cool Down** _____ 14
- **Maintenance** _____ 15
- **2 Year Limited Warranty** _____ 16
- **Repairs Procedure** _____ 17

IMPORTANT SAFETY INSTRUCTIONS

It is the sole responsibility of the purchaser of Trojan products to read the owner's manual, warning labels and instruct all individuals, on proper usage of the equipment. Understanding each and every warning to the fullest is important. If any of these instructions or warnings are unclear please contact Trojan Customer Services on **0861 TROJAN (0861 876526)**, within the Republic of South Africa. Customers residing outside South Africa can contact us on +27 10 206 4405.

The equipment is only intended for home use and is not intended for commercial, institutional and/or studio facilities use.

Contact Trojan with any questions regarding this classification. It is recommended that all users of Trojan be informed of the following information prior to use.



HEALTH WARNING

- Before starting any exercise or conditioning program you should consult with your personal physician to see if you require a complete physical exam. This is especially important if you are inactive, pregnant or suffer from any illness.
- If at any time during exercise you feel faint, dizzy or experience pain, stop exercising immediately and consult your physician.
- To avoid muscular pain and strain, begin each workout by stretching and warming up and end each session by cooling down and stretching.



INSTALLATION

Trojan recommends that all equipment:

- Be secured to or set up on a solid, level surface to stabilise and eliminate rocking or tipping over during training.
- Be set up inside your home away from moisture and dust (the equipment is not designed for outdoor use).
- Be set up with sufficient ventilation to ensure proper operation.
- Be set up with sufficient space around the equipment so that all exercises can be completed safely. It is recommended that there should be at least 1 m of space around the equipment where access is required to exercise.



PROPER USAGE

- Do not use the equipment in any way other than as designed or intended by the manufacturer. It is imperative that Trojan equipment is used properly to avoid injury.
- Injuries may result from exercising improperly or excessively.
- Your Trojan equipment should only be used by 1 person at a time.
- Be careful to maintain your balance while using, mounting, dismounting or assembling your Trojan equipment to avoid injury.
- Servicing other than the procedures in this manual should be performed by an authorised service representative only.

IMPORTANT SAFETY INSTRUCTIONS

ACCESS CONTROL

- Trojan recommends that all fitness equipment be used in a supervised area. It is recommended that the equipment be located in an access controlled area. Control is the responsibility of the owner. Keep children away from all equipment.
- Parents or others supervising adults must provide close supervision of children if the equipment is used in the presence of children.

INSPECTION

- Do not use or permit use of any equipment that is damaged, or has worn or broken parts. For all Trojan equipment use only replacement parts supplied by Trojan.
- Always make sure that all nuts and bolts are tightened prior to each use.
- Maintain labels and nameplates – do not remove labels for any reason. They contain important information.
- Equipment maintenance – preventative maintenance is the key to smooth operating equipment. Please ensure that you follow our maintenance tips to ensure the continued correct function of your Trojan equipment.
- Before any use, examine all accessories approved for use with the Trojan equipment for damage or wear. Should your Trojan equipment appear damaged or worn, do not attempt to use or repair the equipment yourself.
- Please contact our service department on **0861 TROJAN (0861 876526)** to arrange a repair. Customers residing outside South Africa can contact us on +27 10 206 4405.

OPERATING WARNINGS

- It is the purchaser's responsibility to instruct all users as to the proper operating procedures of all Trojan equipment.
- Keep children away from all moving parts. Parents must provide close supervision of children if the equipment is used in the presence of children.

Do not wear loose fitting clothing or jewellery when using the equipment. It is also recommended that users tie up long hair to avoid contact with moving parts.

USER WEIGHT LIMITATIONS

- This Trojan Dumbbell Pro 300 Bench may not be used by persons weighing more than 100 kg

SAVE THIS INSTRUCTION MANUAL FOR FUTURE USE AND REFERENCE.

If any of these instructions or warnings are unclear please contact Trojan Customer Services on **0861 TROJAN (0861 876526)** within the Republic of South Africa or visit **www.trojanhealth.co.za**. Customers residing outside South Africa can contact us on +27 10 206 4405.







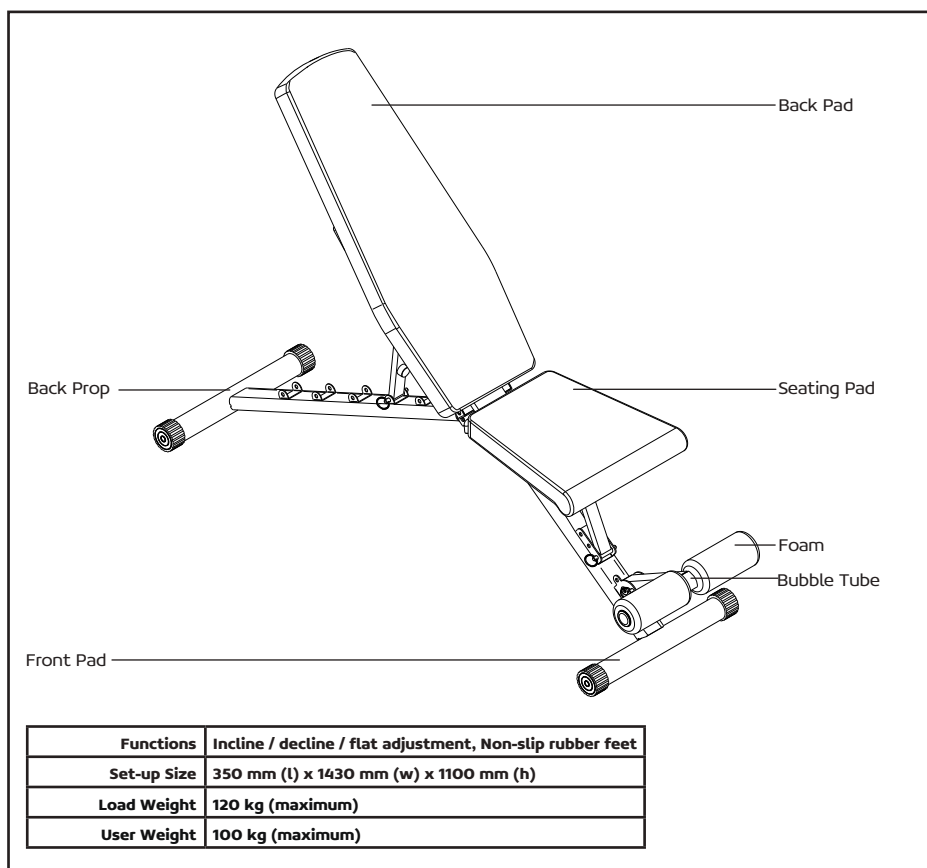





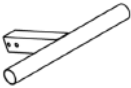

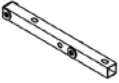



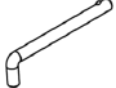

PRE ASSEMBLY CHECK LIST

Thank you for choosing the Trojan Dumbbell Pro 300 Bench. We take great pride in producing this product and hope it will provide many hours of quality exercise to make you feel better; look better and enjoy life to its fullest. Yes, it's a proven fact that a regular exercise program can improve your physical and mental health. Too often, our busy lifestyles limit our time and opportunity to exercise. The Trojan Dumbbell Pro 300 Bench provides a convenient and simple method to begin your assault on getting your body in shape and achieving a healthier lifestyle. Before reading further, please review the drawing below and familiarise yourself with the parts that are labeled.

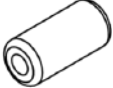
Read this manual carefully before using the Trojan Dumbbell Pro 300 Bench.

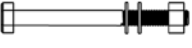

HARDWARE & TOOL LIST

 <p>1. Front Prop (1 PC)</p>	 <p>2. Rear Prop (1 PC)</p>	 <p>3. Foam Tube (1 PC)</p>	 <p>4. Back Pad Tube (R) (1 PC)</p>
 <p>5. Back Pad Tube (L) (1 PC)</p>	 <p>6. Seat Pad Pipe (2 PCS)</p>	 <p>7. Back Pad Adjusting Tube (1 PC)</p>	 <p>8. Seat Pad Adjusting Tube (1 PC)</p>
 <p>9. Back Pad (1 PC)</p>	 <p>10. Seat Pad (1 PC)</p>	 <p>11. Sheet Iron (1 PC)</p>	 <p>12. Bandage (1 PC)</p>
 <p>13. Pin (ø10 x 100 mm) (1 PC)</p>	 <p>14. Pin (ø8 x 45 mm) (3 PCS)</p>	 <p>15. Rubber Feet (4 PCS)</p>	 <p>16. Square Pipe Bushing (1 PC)</p>
 <p>17. Lining (8 PCS)</p>	 <p>18. Foam (2 PCS)</p>	 <p>19. Round Plug (2 PCS)</p>	 <p>20. Seat Pad Washer (2 PCS)</p>
 <p>21. Screw (M10 x 155 mm) (4 PCS)</p>	 <p>22. Screw (M10 x 40 mm) (1 PC)</p>	 <p>23. Screw (M8 x 50 mm) (1 PC)</p>	 <p>24. Screw (M8 x 40 mm) (8 PCS)</p>

PARTS LIST

No.	Description	Qty
1	Front Prop	1
2	Rear Prop	1
3	Foam Tube	1
4	Back Pad Tube (R)	1
5	Back Pad Tube (L)	1
6	Seat Pad Pipe	2
7	Back Pad Adjusting Tube	1
8	Seat Pad Adjusting Tube	1
9	Back Pad	1
10	Seat Pad	1
11	Sheet Iron	1
12	Bandage	1
13	Pin (ø10 x 100 mm)	1
14	Pin (ø8 x 45 mm)	3
15	Rubber Feet	4
16	Square Pipe Bushing	1
17	Lining	8
18	Foam	2
19	Round Plug	2
20	Seat Pad Washer	2
21	Screw (M10 x 155 mm)	4
22	Screw (M10 x 40 mm)	1
23	Screw (M8 x 50 mm)	1
24	Screw (M8 x 40 mm)	8

EXPLODED DRAWING

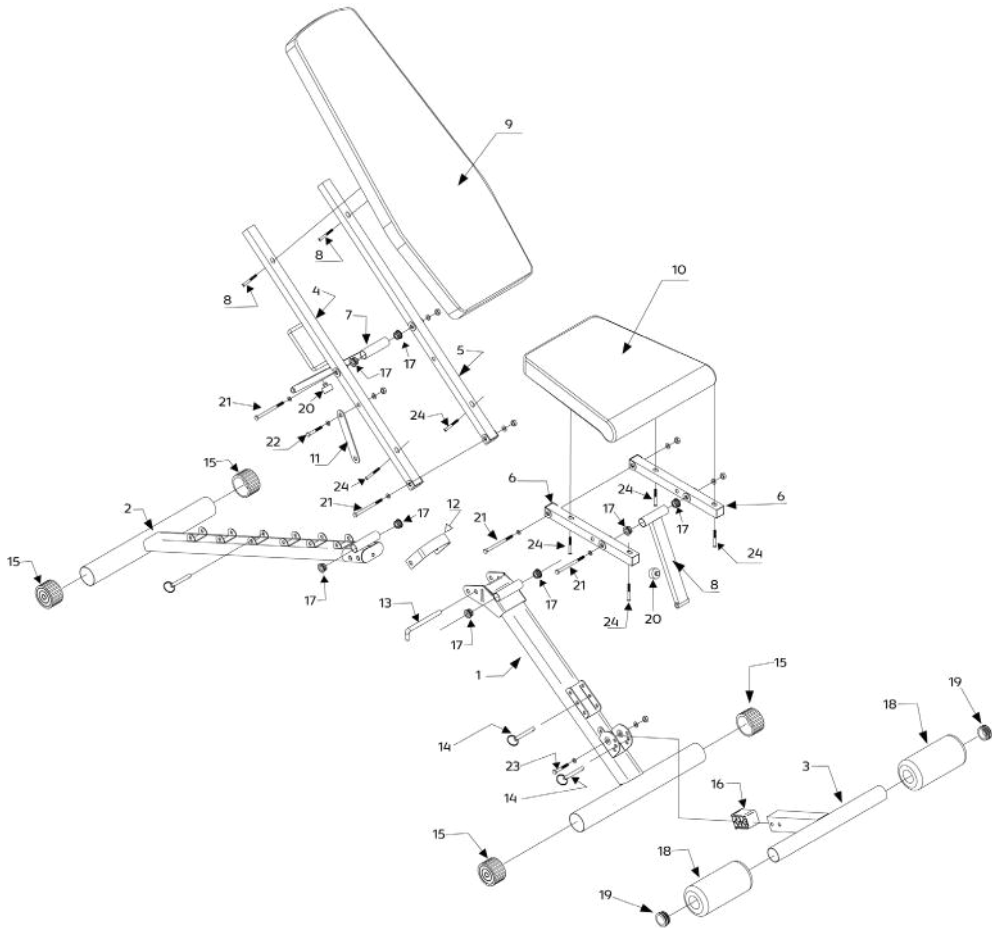

FOLDING STEPS



STEP 1:

Pull out the 3 Pins ($\text{\textcircled{8}}$ x 45 mm) (14) as shown in the figure to the left. Then flatten Back Pad (9), Seat Pad (10), and Foam Tube (3).

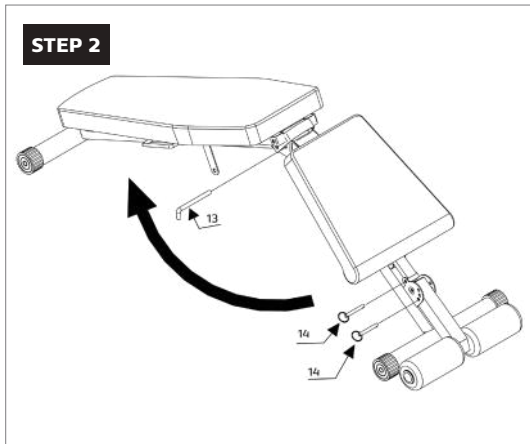

STEP 2:

Insert the 2 Pins ($\text{\textcircled{8}}$ x 45 mm) (14) as shown in figure to the left. This will secure the Back Pad (9) and Foam (18) to pull the Pin ($\text{\textcircled{10}}$ x 100 mm) (13) out.

FOLDING STEPS

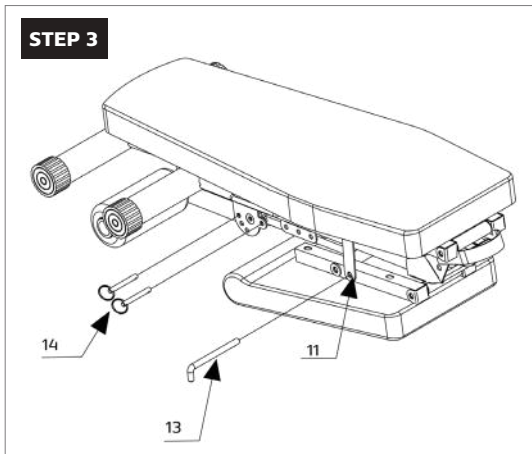

STEP 3:

Insert both Pins ($\varnothing 8 \times 45$ mm) (14) and secure the Back Pad Tubes (4, 5) with the Sheet Iron (11) as shown in the figure to the left.

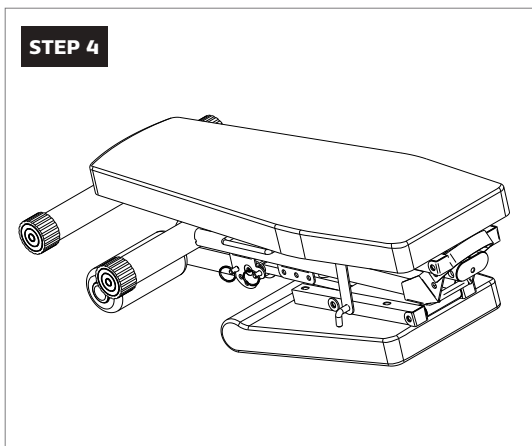

STEP 4:

Shows the folded product.

EXERCISE INSTRUCTIONS

Using your Trojan Dumbbell Pro 300 Bench used with weights provides you with several benefits, it will improve your physical fitness, tone muscle and in conjunction with a calorie controlled diet, help you lose weight.

THE WARM UP PHASE

This stage helps get the blood flowing around the body and the muscles working properly. It will also reduce the risk of cramp and muscle injury. It is advisable to do a few stretching exercises as shown below. Each stretch should be held for approximately 30 seconds, do not force or jerk your muscles into a stretch. If it hurts, **STOP**.

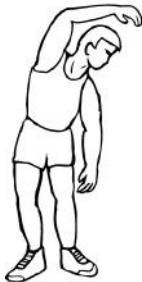

SIDE BENDS



FORWARD BENDS



OUTER THIGH



INNER THIGH

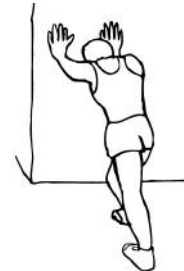

CALF STRETCH

This is the stage where you put the effort in. After regular use, the muscles in your whole body will become stronger. Work at your own pace, but it is very important to maintain a steady tempo throughout. The rate of work should be sufficient to raise your heart beat into the target zone shown on the graph below.

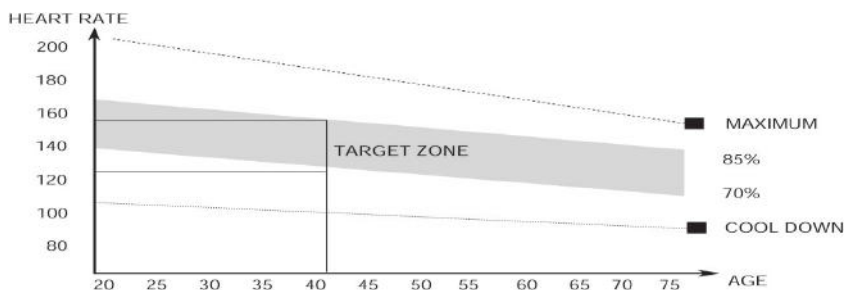

This stage is to let your Cardiovascular System and muscles wind down. This is a repeat of the warm up exercise i.e. reduce your tempo, continue for approximately 5 minutes. The stretching exercises should now be repeated, again remembering not to force or jerk your muscles into the stretch.

As you get fitter you may need to train longer and harder. It is advisable to train at least 3 times a week, and if possible space your workouts evenly throughout the week.

FITNESS TIPS & TECHNIQUES

AEROBIC EXERCISE

Aerobic exercise is any sustained activity that sends oxygen to your muscles via your heart and lungs. Aerobic exercise improves the fitness of your lungs and heart – your body's most important muscle. Aerobic exercise fitness is promoted by any activity that uses your large muscles (arms, legs, or buttocks, for example). Your heart beats quickly and you breathe deeply. An aerobic exercise should form part of your entire exercise routine.

WEIGHT TRAINING

Along with aerobic exercising which helps get rid of and keep off the excess fat that our bodies can store, weight training is an essential part of the exercise routine process. Weight training helps tone, build and strengthen muscle. If you are working above your target zone, you may want to do a lesser amount of reps. Always consult your physician before beginning any exercise program.

MUSCLE CHART

The exercise routine that is performed when using Trojan Dumbbell Pro 300 Bench will develop the whole body muscle as well as condition the circulatory system and provide a good aerobic workout. These muscle groups are highlighted on the muscle chart below.

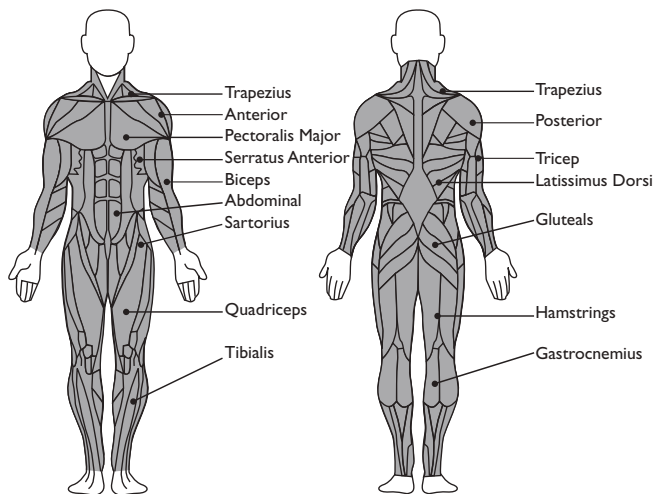

VISIT:
www.trojanhealth.co.za for equipment choices and exercise programs

CONDITIONING GUIDELINES

How you begin your exercise program depends on your physical condition. If you have been inactive for several years, or are severely overweight, you must start slowly and increase your time on the equipment; a few minutes per workout. Initially, you may be able to exercise only for a few minutes in your target zone, however, your aerobic fitness will improve over the next 6 to 8 weeks. Don't be discouraged if it takes longer. It's important to work at your own pace. Ultimately, you'll be able to exercise continuously for 30 minutes. The better your aerobic fitness, the harder you will have to work to stay in your target zone. Please remember these essentials:

- Have your doctor review your training and diet programs to advise you of a workout routine you should adopt
- Begin your training program slowly with realistic goals that have been set by you and your doctor. Monitor your pulse frequently.
- Establish your target heart rate based on your age and condition.

EXERCISE INTENSITY

To maximise the benefits of exercising, it is important to exercise with the proper intensity. The proper intensity level can be found by using your heart rate as a guide. For effective aerobic exercise, your heart rate should be maintained at a level between 65% and 85% of your maximum heart rate as you exercise. This is known as your target zone. You can find your target zone in the table below.

During the first few months of your exercise program, keep your heart rate near the low end of your target zone as you exercise. After a few months, your heart rate can be increased gradually until it is near the middle of your target zone as you exercise.

To measure your heart rate, stop exercising but continue moving your legs or walking around and place 2 fingers on your wrist. Take a 6 second heartbeat count and multiply the results by 10 to find your heart rate. For example, if your 6 second heartbeat count is 14, your heart rate is 140 beats per minute. (A 6 second count is used because your heart rate will drop rapidly when you stop exercising). Adjust the intensity of your exercise until your heart rate is at the proper level.

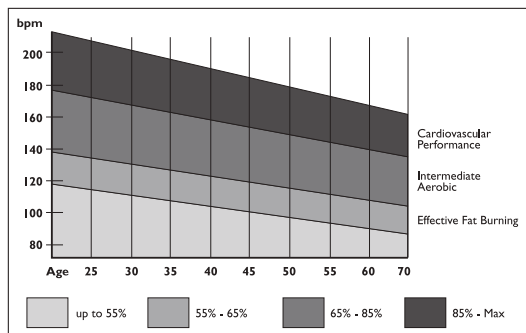
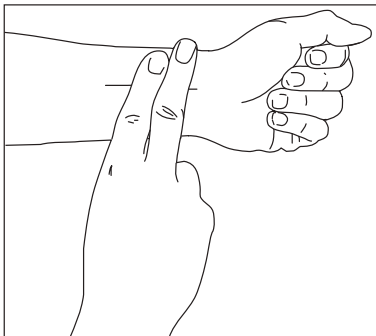

WARM UP & COOL DOWN

WORKOUT GUIDELINES

Each workout should include the following 3 parts:

- 1. A WARM-UP:** 5 to 10 minutes of stretching and light exercise. A proper warm-up increases your body temperature, heart rate, and circulation in preparation for exercise.
- 2. TRAINING ZONE EXERCISE:** 20 to 30 minutes of exercising with your heart rate in your training zone. (Note: During the first few weeks of your exercise program, do not keep your heart rate in your training zone for longer than 20 minutes).
- 3. COOL-DOWN:** 5 to 10 minutes of stretching. This will increase the flexibility of your muscles and will help to prevent post-exercise problems.

EXERCISE FREQUENCY

To maintain or improve your condition, plan 3 workouts each week, with at least 1 day of rest between workouts. After a few months of regular exercise, you may complete up to 5 workouts each week, if desired. Remember, the key to success is to make exercise a regular and enjoyable part of your everyday life.

SUGGESTED STRETCHES

The correct form for several basic stretches are shown on the right. Move slowly as you stretch, hold the position and never bounce.

1. TOE TOUCH STRETCH

Stand with your knees bent slightly and slowly bend forward from your hips. Allow your back and shoulders to relax as you reach down toward your toes as far as possible. Hold for 15 counts, and then relax. Repeat 3 times.

Stretches: Hamstrings, back of knees and back.

2. HAMSTRING STRETCH

Sit with one leg extended. Bring the sole of the opposite foot toward you and rest it against the inner thigh of your extended leg. Reach toward your toes as far as possible. Hold for 15 counts, and then relax. Repeat 3 times for each leg.

Stretches: Hamstrings, lower back and groin.

3. CALF/ACHILLES STRETCH

With 1 leg in front of the other, reach forward and place your hands against a wall. Keep your back leg straight and your back foot flat on the floor. Bend your front leg, lean forward and move your hips toward the wall. Hold for 15 counts, and then relax. Repeat 3 times for each leg. To cause further stretching of the Achilles tendons, bend you back leg as well.

Stretches: Calves, Achilles tendons and ankles.

4. QUADRICEPS STRETCH

With 1 hand against a wall for balance, reach back and grasp one foot with your other hand. Bring your heel as close to your buttocks as possible. Hold for 15 counts, then relax. Repeat 3 times for each leg.

Stretches: Quadriceps and hip muscles.

5. INNER THIGH STRETCH

Sit with the soles of your feet together and your knees outward. Pull your feet toward your groin area as far as possible. Hold for 15 counts, and then relax. Repeat 3 times.

Stretches: Quadriceps and hip muscles.





MAINTENANCE

CLEANING

The Trojan Dumbbell Pro 300 Bench can be cleaned with a soft cloth and mild detergent. Do not use abrasives or solvents on plastic parts.

STORAGE

Keep the Trojan Dumbbell Pro 300 Bench in a clean and dry environment away from children.

2 YEAR LIMITED WARRANTY

The Manufacturer hereby provides a warranty to the original purchaser of this product ('the Consumer') that this product will be free of manufacturing defects in materials and workmanship which under normal, personal, family or household use (commercial use expressly excluded) manifest themselves within the 2 years from the date of purchase.

EXCLUSIONS

- The warranty does not include and will not be construed to cover products damaged as a result of disaster, misuse, commercial use, not in accordance within the written instructions included with the product, abuse and/or any non-authorized modification of the product, incorrect installation of the product or normal wear and tear.
- All demo models carry a 3 month warranty.

WAIVER

The warranty and the obligations of the Manufacturer provided herein are in lieu of, and the Consumer, waives all other warranties, guarantees, conditions or liabilities, express or implied, arising by law or otherwise, including without limitation, any obligation of the Manufacturer in respect of any injury, loss or damage (direct, indirect or consequential) arising out of the use of, or inability to use this product and whether or not occasioned by the Manufacturer's negligence or any act or omission on its part.

PROOF OF PURCHASE

Any claim in terms of the warranty must be supported by a proof of purchase or a warranty number.

Warranty numbers can be issued through contacting our Trojan Call Centre on 0861 Trojan (0861 876526) or online at www.trojanhealth.co.za. Customers residing outside South Africa can contact us on +27 10 206 4405. If such proof is not available, then notwithstanding anything to the contrary herein, the service agent's prevailing charges for services/repairs including call out and/or spares will be payable by the Consumer upon collection or delivery of the repaired product.

The Consumer does not need to return the product to the store. The Consumer should call the Trojan Call Centre on 0861 Trojan (0861 876526). Customers residing outside South Africa can contact us on +27 10 206 4405 and the call centre will advise of the procedure. During the warranty period the product may only be serviced and/or repaired by the Manufacturer's duly authorised agent(s).

TROJAN	ATTACH RECEIPT
CLIENT DETAILS	
NAME: _____	
EMAIL: _____ CELL: _____	
TEL(H): _____ TEL(W): _____ FAX: _____	
ADDRESS: _____	

PRODUCT DETAILS	
DATE OF PURCHASE: dd / mm / yy SERIAL NUMBER: _____ TILL SLIP NUMBER: _____	
DESCRIPTION OF PURCHASE: _____	

BRANCH PURCHASED AT	

0861 TROJAN (0861 876526) / +27 10 206 4405	WWW.TROJANHEALTH.CO.ZA

REPAIRS PROCEDURE

Should you experience any faults or breakdowns on your Trojan equipment, please adhere to the following procedure to have the fault rectified speedily and professionally.

Do not return the product to the store.

Call the Trojan Call Centre on 0861 Trojan (0861 876526) to log the faulty product (under warranty or out of warranty). Customers residing outside South Africa can contact us on +27 10 206 4405.

The operator or technical advisor will try identify the fault, and will book a service team call out.

The service team will endeavour to fix the problem in your home on an agreed date and time.

Only if the fault cannot be repaired in the convenience of your home, will the service team take the faulty product back to the service centre.

Items repaired in our service centre will be returned to your home on an agreed date and time.

Note: Should you live in an outlying area or outside South Africa, it may be necessary to return the product to the store nearest to you. Our service operator will advise you of your repair procedure.

COST OF REPAIRS

UNDER WARRANTY

Any items still under warranty will be repaired free of charge, as long as it complies with the terms and conditions of the warranty (refer to "warranties" section in this manual). Any items that need to be repaired that are NOT covered in the warranty will be for the Consumer's expense. A quote for the repair/replacement of these items will be provided to the Consumer for approval prior to repairs being conducted.

OUT OF WARRANTY

Any items that need to be repaired once the warranty has expired will be for the Consumer's expense including call out fees.

A quote for the repair/replacement of these items will be provided to the Consumer for approval prior to repairs being conducted.

2 YEAR WARRANTY

If this product proves to be faulty during normal use due to defective materials or workmanship. Refer to user manual or website for terms and conditions.

0861 876 526
0861 TROJAN
+27 10 206 4405

Please call us for any product queries, after sales support, repairs or installations.

Manufactured for Masstores (Pty) Ltd.
16 Peltier Drive, Sunninghill, Ext 6, Sandton, 2146, South Africa.

MADE IN CHINA

Always consult a physician before starting a new exercise routine

Use in conjunction with a healthy eating plan

Only use product for its intended purpose to prevent injury

Visit facebook.com/trojanhealth
www.trojanhealth.co.za
www.instagram.com/trojanhealth

Like us on
facebook

#19M04T012